

# AURA™ PRO UNDERGLOW

— WITH DOOR ASSIST —  
INSTALLATION GUIDE

## COMPONENTS



RIGID LIGHT BARS 2×48" (TWO-SECTION MOVABLE 24")



RIGID LIGHT BARS 2×36" (TWO-SECTION MOVABLE 18")

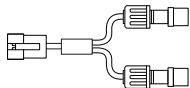

Y-SPLITTERS

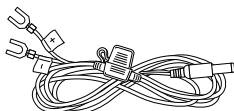

HARDWIRE POWER HARNESS



AURA BLUETOOTH CONTROL BOX

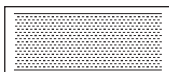
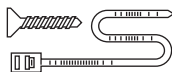

INCLUDES -  
WIRE MOUNTS, SELF-TAPPING  
SCREWS, BOOSTER, VELCRO, ZIP TIES

MOUNTING KIT

# INSTALLATION

## STEP 1

Inspect kit to ensure all contents was included.

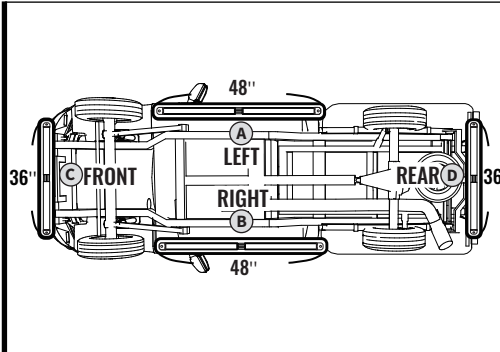

## STEP 2

Decide where to locate the control box and ensure wiring has enough length for light bars to be installed in desired location.

### IMPORTANT:

The control box must be installed inside the vehicle as it is not waterproof. Avoid installation areas of the engine bay + heated surfaces.

## EXAMPLES

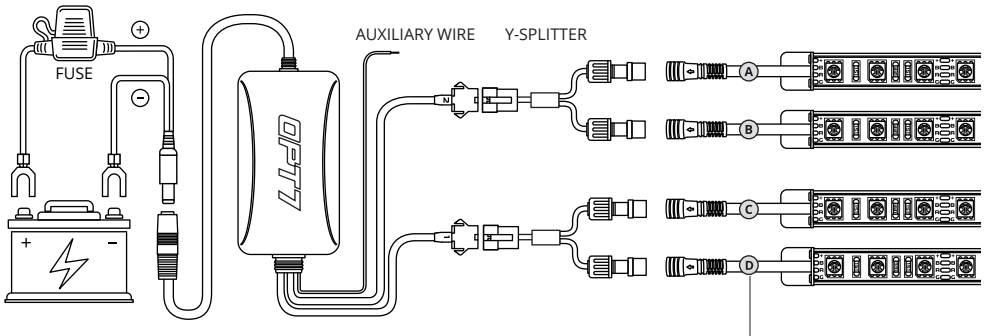

The extension wires are on the led bar.

Lay out the bars to measure the length prior to install for a successful installation.

- Ⓐ 1 x 48" (two-section movable 24") LED Bar + 8ft extension wire
- Ⓑ 1 x 48" (two-section movable 24") LED Bar + 8ft extension wire
- Ⓒ 1 x 36" (two-section movable 18") LED Bar + 8ft extension wire
- Ⓓ 1 x 36" (two-section movable 18") LED Bar + 18ft extension wire



### WARNING

1. Connecting to more than 10 AMP will override the kit and cause early failure, ensure it is 10 AMP or less!!
2. Please ensure that the LED bars or strips/control box/wiring all are mounted in areas where will not exceed 85°C or 185°F.

# INSTALLATION

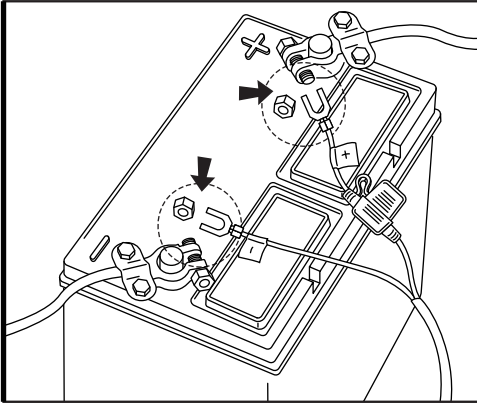

## HOW TO CONNECT POWER HARNESS TO YOUR VEHICLE

- Connect the Red wire (+) of power harness to the vehicle battery's positive terminal.
- Connect the Black wire (-) of power harness to the vehicle battery's negative terminal or an unpainted area on your vehicle's frame.



### WARNING

1. Connecting to more than 10 AMP will override the kit and cause early failure, ensure it is 10 AMP or less!!
2. Please ensure that the LED bars or strips/control box/wiring all are mounted in areas where will not exceed 85°C or 185°F.

## ⚠ IMPORTANT ⚠

**BE SURE TO CONFIRM THE CORRECT DIRECTION OF THE ARROW!!  
TO AVOID PRODUCT DAMAGE DUE TO INCORRECT INSTALLATION.**

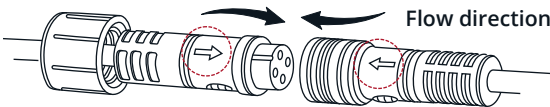

Note the direction of the arrows

**CORRECT INSTALLATION**

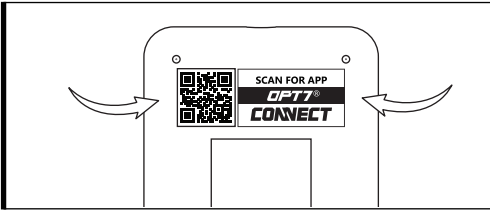

### STEP 3

Scan the QR code on the back of the control box to download the app.

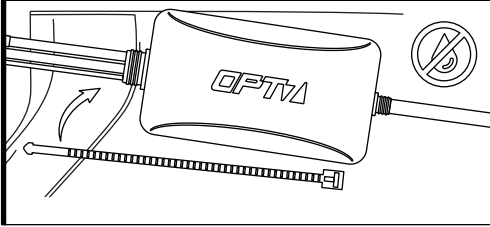

### STEP 4

Secure Control box in desired location with Velcro or zip ties.

\* The control box is NOT waterproof. Tuck it away from the elements.

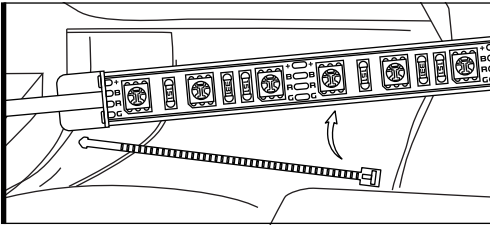

### STEP 5

Secure the light bars using the zip ties to tie all the wiring away from the moving components.

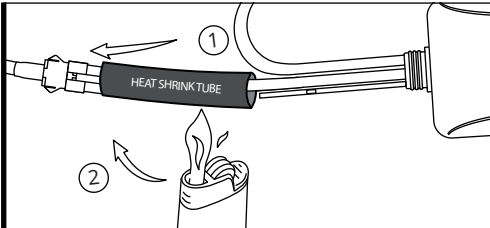

**\* IMPORTANT:**

The LED connectors are not waterproof. You will need to use HEAT SHRINK TUBE (not included) or ELECTRICAL TAPE around the LED connectors to ensure the longevity of the lighting kit.

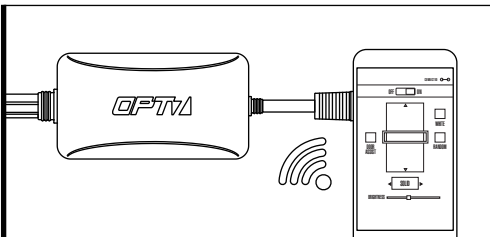

### STEP 6

Open the "OPT7 Connect" App, pair your smart phone to the control box, and pick your desired color!

## | AUX WIRING FOR A DOOR/DOME LIGHT



Please scan to see a detail instruction on Door Assist Sync or go to <https://wintis.ladesk.com/549690-AURA-Door-AssistAUX-Installation-Guide>

## | OPT7 CONNECT APP

- Colors
- Modes
- Door Assist
- Support
- Ability to control up to 4 devices at once

### QR CODE TO DOWNLOAD



Download the free "OPT7 CONNECT" App

- App iOS (12+) available on App Store
- Android (6 +) available on Google Play

## | DISCLAIMER

OPT7 Lighting is not liable for damages or personal injuries while installing this product. The Installation Guide is intended as assistance to reduce setup time. OPT7 Lighting assumes no responsibility for improper installation. If you are unfamiliar with your vehicle or inexperienced with aftermarket upgrades, please seek professional assistance.

OPT7 recommends installation for safety and guidance.

Modified installations or installation recommendations not specified by OPT7 Lighting will void product warranty.